

QUICK VISION SERIES CNC Vision Measuring System

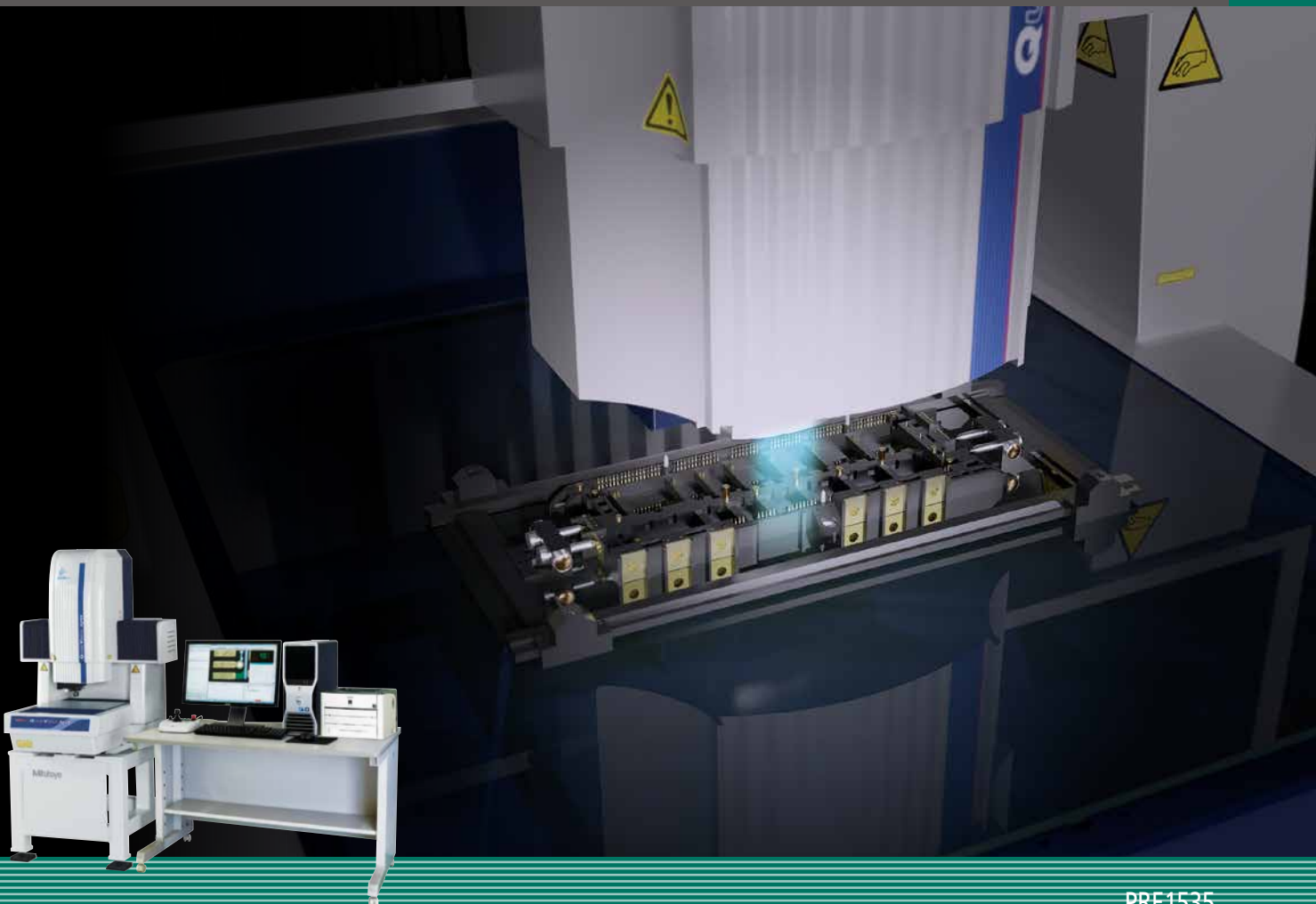

Innovative Technique

Highly Advanced Non-contact Measurement Technologies

Developed around its autofocus function, this well-designed main unit structure provides nothing but the best high-accuracy measurements. The Quick Vision Series, our CNC vision measuring machine family is ever evolving. Through the integration of various high-performance technologies, 3D non-contact measurement is now a reality.

This vision machine family not only makes edge detection and object dimension measurement with no contact possible but also extremely easy.

- **Measures an object's microscopic features in a magnified image**
You can capture the magnified image of an object through the optical lens system. Effective for measurement of small, thin objects such as electronic parts, semiconductor parts, precision parts, and medical device parts.
- **Non-contact measurement prevents damage, deformation, and contamination of the object**
By using non-contact measurement, the risk of damaging objects is eliminated. It is particularly effective for the measurement of electronic or semiconductor parts that require cleanliness, as well as soft objects such as plastic molded parts or thin press-molded parts.
- **High-speed multiple point measurement**
Our honed image processing technology and high-speed stage control function deliver high-throughput measurements. It is effective for process control of an object with many measurement points or mass-produced objects.
- **High-accuracy non-contact height measurement**
High-performance image autofocus and a non-contact displacement sensor enable high-accuracy non-contact height measurement.

Mitutoyo Compliments Manufacturing Processes Across All Industries

MEDICAL

Medical devices requiring high accuracy

Medical devices directly affect people's health and life every component requiring strict adherence to demanding accuracy specifications. A good example of this would be the lens and forceps of an endoscope which are installed in a tip with a minimum diameter of 3 mm. Thanks to its 4,300X magnification, various types of autofocus, and high-resolution edge detection, the Quick Vision Series helps you measure objects without making contact in applications that require accuracy at the most minute level. Its improved repeatability and technical measurement capabilities have been proven equivalent to those of the global standard. To respond to the demands of emergency medical care, medical devices need to satisfy more requirements. Through improving our measurement technologies in the manufacturing of medical devices, Mitutoyo is committed to contributing to the advancement of medical technology.



Example of measuring a valve used in medical equipment





Ultra-small dimension measurement

Through combining ten different objective lenses with the built-in imaging lens, a maximum of 150X optical magnification (4,300X total on-monitor magnification) can be achieved. This enables measurement of ultra-small parts, such as medical device components.

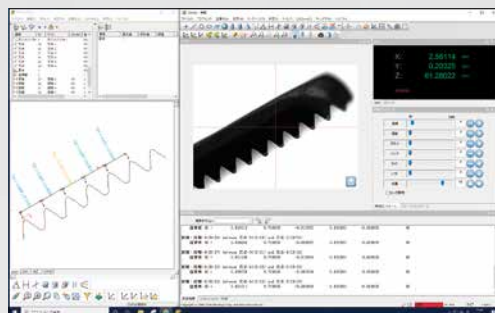

Example of image measurement for medical forceps

High-accuracy 3D measurement

High-accuracy height measurement using single focus high-resolution images and PFF (Point From Focus) enable 3D capturing of the object shape, thereby expanding the scope of measurement.

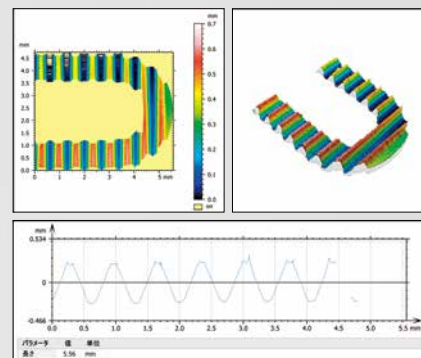

3D analysis of the shape captured by PFF MCubeMap

AUTOMOBILE

Flexible measurement of new parts for electric vehicles

With the increasing demand for reducing greenhouse gas emissions, automobile production is shifting from gas and diesel vehicles to electric, causing the key automobile parts to become electric motors, batteries, and semiconductors at an increasingly rapid rate.

The Quick Vision Series is optimal for use in a variety of manufacturing processes, a few examples of this are pre-stacked motor core parts that are thin and difficult to touch for measurement, fuel cell separators that have minuscule surface irregularities and require very-low-speed measurement, and semiconductor parts inside inverters that require high-speed measurement of microscopic features.

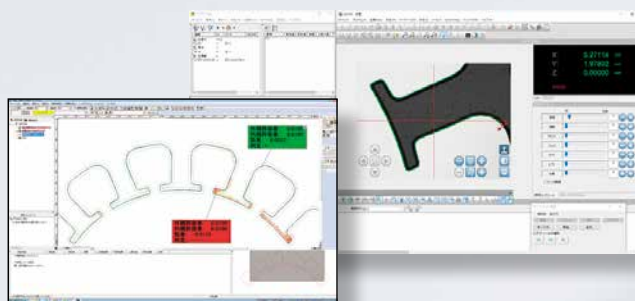

Example of comparison of measurement results with design values

Meeting the rigorous quality control standards of the automobile industry

The introduction of CASE (Computer-Aided Software Engineering) technologies continues to drive the demand for electronic and semiconductor parts in the automobile industry. The Quick Vision helps quality control departments within this industry by providing a single machine with both contact and non-contact measurement technologies.



Example of measuring an engine control unit

Offline teaching from a 3D CAD model

In addition to the existing function for creating programs from 3D CAD model images, we have developed offline programming. This makes it possible to create a program offline from an image or with a touch probe, meaning you can increase the up-time of the QV main unit and shorten production lead times.

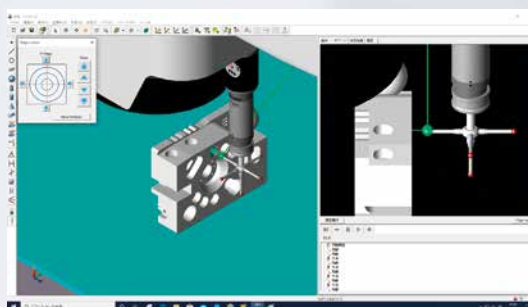

Offline teaching from a 3D CAD model

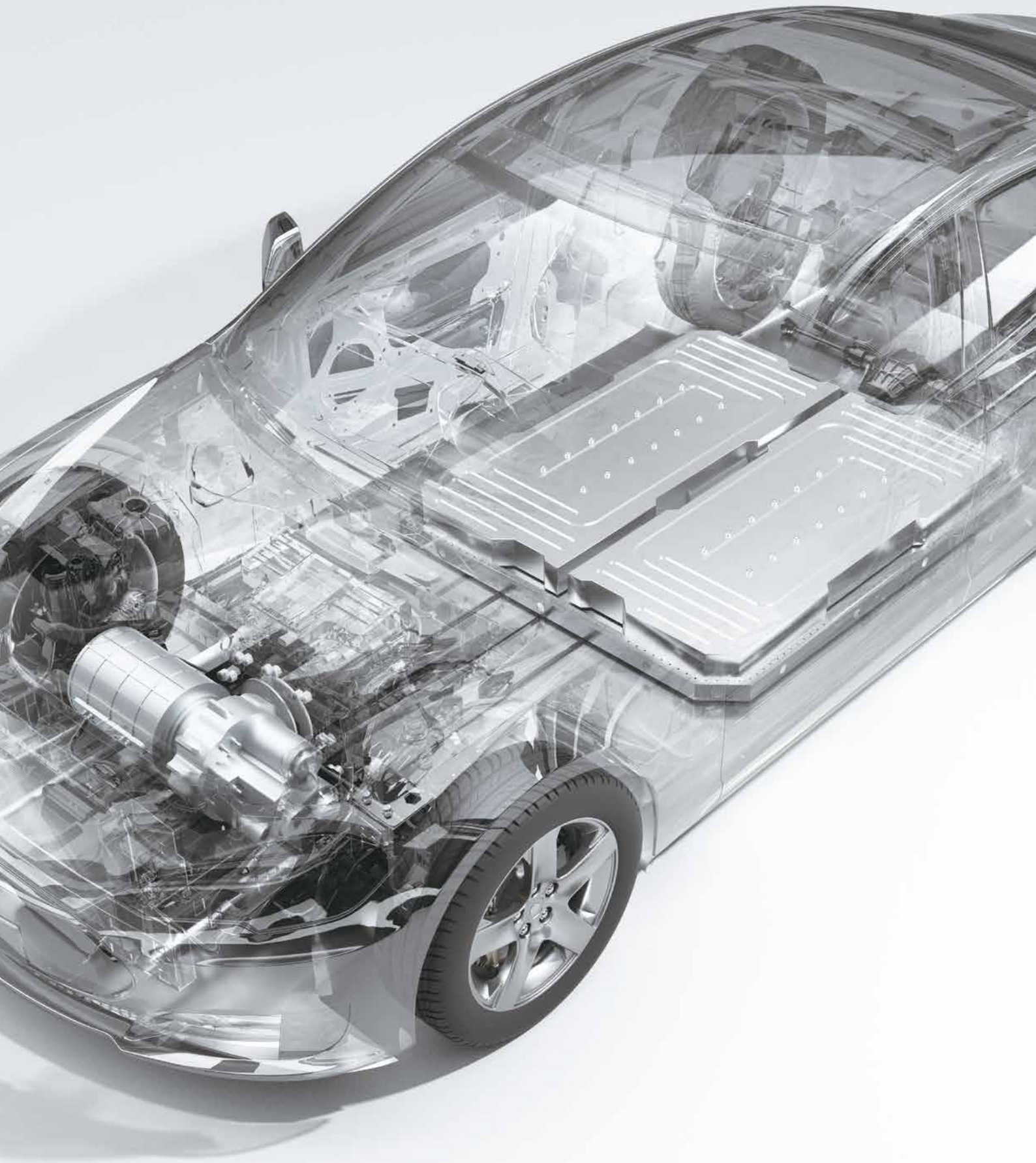

ELECTRONIC PARTS

Continuous measurement during mass production

The shift in production to electric vehicles, expansion of services promoted by commercialized 5G, and recovery of capital investment in data centers are all signs of growth in the semiconductor market. QV STREAM PLUS of the Quick Vision Series synchronizes main unit operation with the strobe of the camera used for measuring and thus enables high-speed measurements to enhance the productivity of semiconductor manufacturing. For example, the continual movement of the stage.

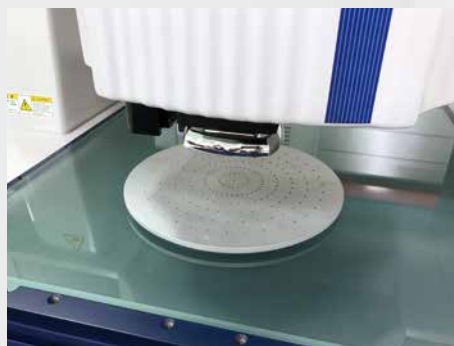

Scan the QR code for a video demonstration



Preventing nonconformities during mass production

Continuous measurement with a QV STREAM PLUS and quick focusing using TAF (Tracking Autofocus) can deliver high-speed measurement. Nonconformities on final products can be prevented by increasing the number of features to measure.



3D measurement with multiple sensors

Surface texture and cross-section texture can be analyzed by combining vision measurement, the non-contact displacement sensor, PFF (Point From Focus), and WLI (White Light Interferometer).

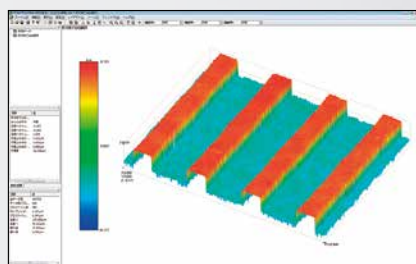

DDPAK - flaw inspection software

DDPAK comes with a flaw inspection function used in the detection of contaminants, burrs, cracks, etc., in addition to dimensional measurement. Highly accurate, this helps find flaws that cannot normally be detected by a typical dimensional measurement.

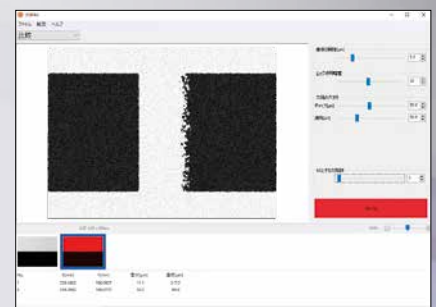



Highly Functional Illumination Unit

- QV-PROs use LEDs for all of their light sources: contour, vertical surface, and programmable ring light.
- Lighting uniformity has been achieved at a high level, which leads to excellent part program compatibility between multiple QVs.
- LED light sources have excellent responsiveness, which improves measurement throughput.
- LED light sources have longer lives than halogen types, which reduces illumination fluctuations and thereby minimizes any errors caused by changes in light intensity.

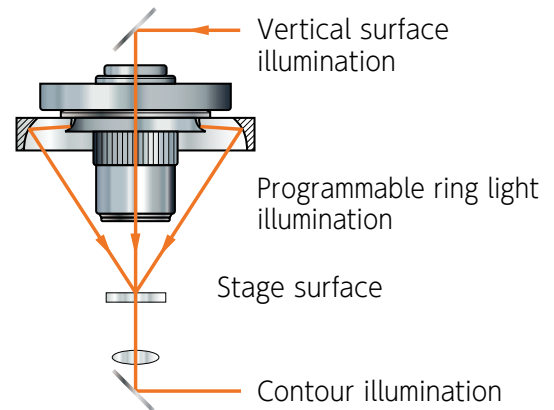

Vertical surface illumination Programmable ring light illumination Contour illumination

Programmable Ring Light (PRL)

Changing the positions of the two curved mirrors sets the ring light's obliquity to any chosen value between 30° and 80°. This is effective for enhancing the edges of inclined surfaces or very small steps.

Furthermore, the PRL light's illumination can be controlled independently in every direction, front and back, right and left. This makes it possible to configure highly variable lighting settings to match measurement locations.

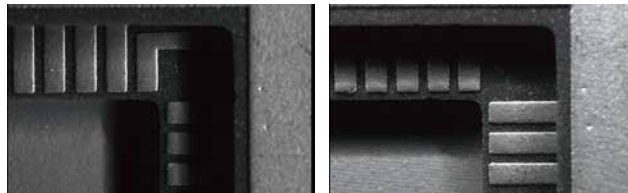

White LED model/Color LED model

The QV Apex and Hyper QV are available as a white LED model or color LED model. The color LED model emphasizes edge contrast between different colors of the object, for example between copper track and plated parts on a printed circuit board. It provides high reproducibility in edge detection.

The pictures to the right show a color LED model demonstrating the contrast-enhancing effects of colored illumination.

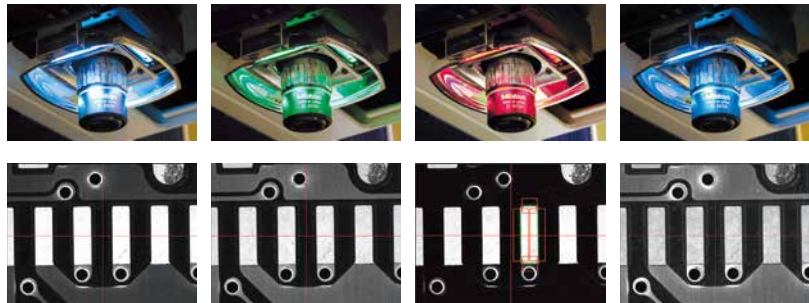

Synthesized white Green Red Blue

Programmable Power Turret

The QV's programmable power turret has excellent magnification repeatability which makes it suited to highly accurate measurements. The standard specification permits three steps of magnification: 1X, 2X, and 6X*.

The rich lineup of objectives contains lenses with magnifications ranging from 0.5X to 25X, which makes it possible to select the optimal optical system to match the measurement target. It is possible to install additional objectives after purchase of the main unit.

* The customized specification permits three or four steps of magnification: 1X, 2X, and 4X; or 1X, 2X, 4X, and 6X.

When using QV-HR1X

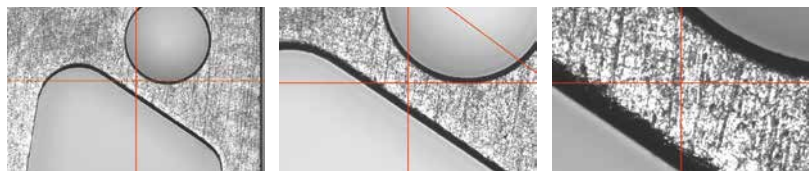

Turret 1X Field of view: 6,27×4,70 mm Turret 2X Field of view: 3,13×2,35 mm Turret 6X Field of view: 1,04×0,78 mm

When using QV-HR10X

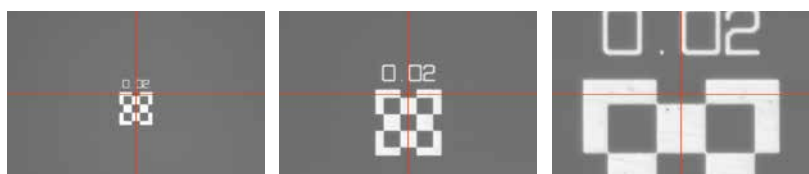

Turret 1X Field of view: 0,62×0,47 mm Turret 2X Field of view: 0,31×0,23 mm Turret 6X Field of view: 0,10×0,07 mm

High-Performance Multi Autofocus

The QV Series is equipped with a high-performance image autofocus function as standard, used for guaranteeing accuracy. Thanks to the availability of various autofocus tools, the optimal focus for each surface texture and measured feature can be selected, which makes it possible to perform highly reliable height measurements. Furthermore, the autofocus operates at high speed, increasing the overall measurement throughput.

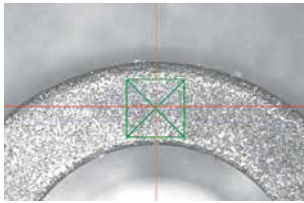

Plastic-molded product

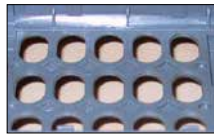

Surface focus

Image autofocus can be used to measure the height of a chosen area, making it possible to perform stable height measurements that are minimally affected by the roughness of machined surfaces and other similar surfaces.

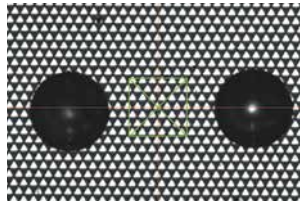

IC package



Pattern focus

Autofocus can be performed on low-contrast transparent objects, such as film, glass, and mirrored surfaces by projecting onto the object surface a pattern placed within the light path.

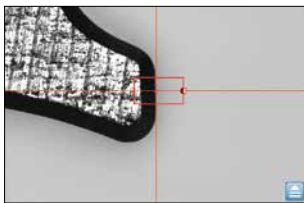

Chamfered part of a machined surface



Edge focus

Edge focus is suited to focusing edges that have been chamfered or that have a corner radius. By using this focus tool prior to performing edge detection improves edge detection reproducibility.

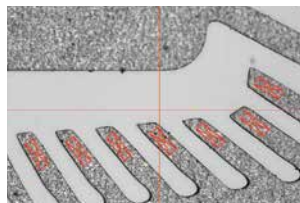

Multi-point autofocus

Multi-point autofocus can be used to set multiple focus positions, sizes, and angles to arbitrary values. This tool can be used to obtain multiple sets of height information with a single focus operation, which makes it possible to perform highly efficient height and flatness measurements.

Well-designed structure for high-accuracy measurement

A Y-axis table moving mechanism with a fixed bridge has been adopted into the basic structure of the main unit. Structural deformation caused by movement along each axis has been minimized, which ensures that the Quick Vision Series can be used to perform highly accurate measurements with minimal spatial coordinate distortions.

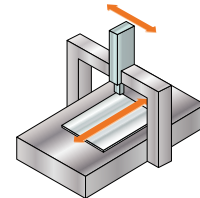

What is true traceability?

Adopting reference instruments traceable to the national standard

To build customer trust, we adhere to traceability national standards.

- Mitutoyo's calibration artifacts and instruments that are used to establish machine accuracy specifications are maintained in a continuous chain of traceability to national dimensional standards. This is our customers' assurance of reliable measurement.
- Our calibration service provider is JCSS certified by IAJapan, which is a certifying body internationally accredited by ILAC in accordance with the MRA (Mutual Recognition Arrangement). It has been qualified for measurement techniques equivalent to those of international calibration organizations.

Note: The chart on the right shows an outline of traceability for our vision measuring systems.



Capable of Supporting ISO10360-7 Guaranteed Accuracy

Some models in the Quick Vision Series support the ISO10360-7: 2011 guaranteed accuracy specifications.

Guaranteed accuracies

- Length measurement error E_L, MPE
- Probing error P_{FZD}, MPE

LINE-UP

A wide array of variations and systems available to broaden measurement applications and improve quality control.

The Quick Vision Series offers a rich lineup with a wide array of measurement ranges and accuracies useful for implementing quality control in all industries, including medical, automobiles, electronics, and semiconductors. It expands measurement applications by combining a vision measuring system that optically magnifies an object image with multiple sensors, including non-contact probes, touch probes, and a white light interferometer.

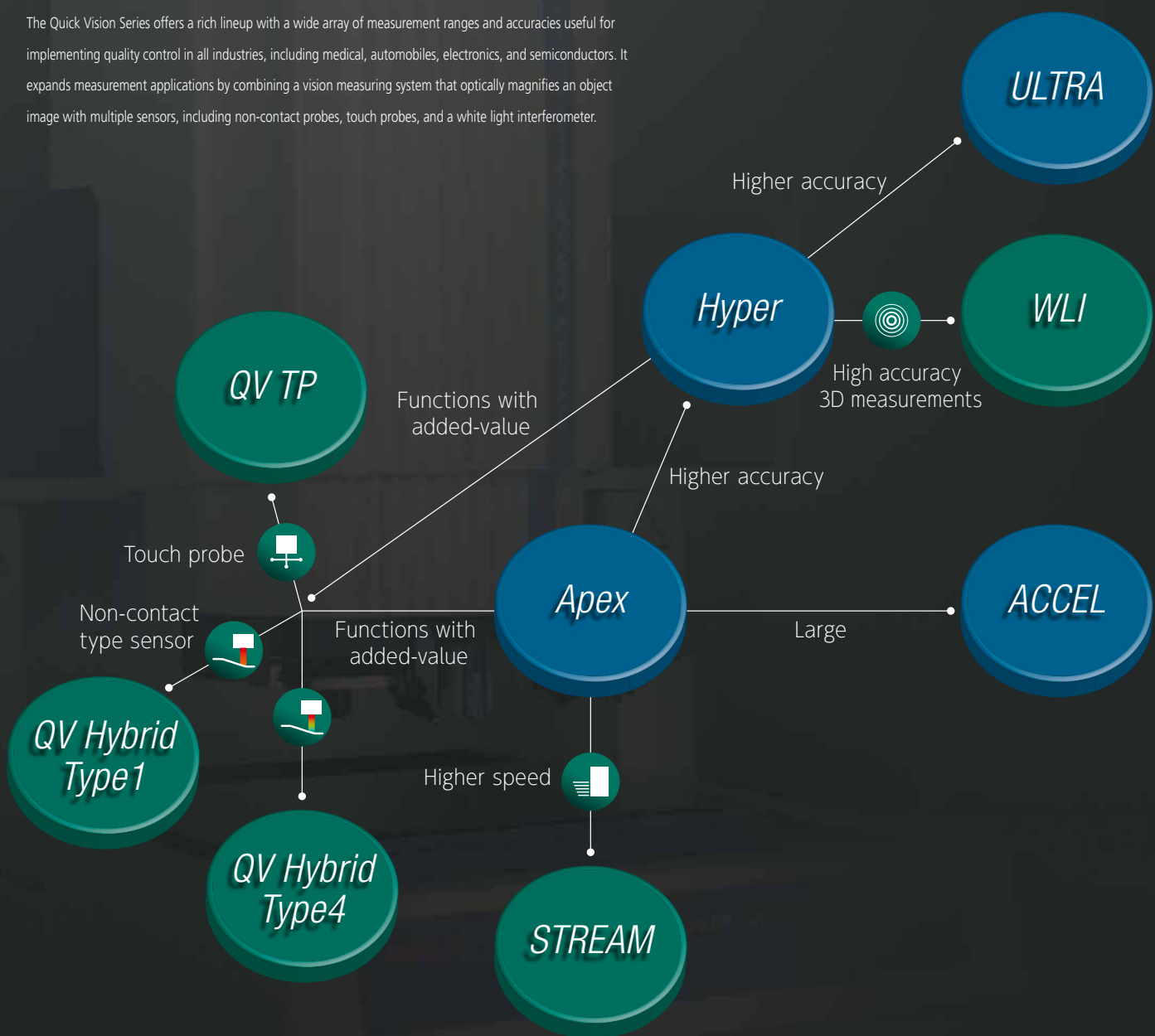



Available



Special order



Not available

QV Apex

Standard CNC Vision Measuring System



- QV Series standard models range in size from compact to large.
- We offer a model with tracking autofocus that can quickly focus on the object and thus improve throughput significantly.
- There is a general-purpose model with white LED light and an enhanced edge detection model with RGB color LEDs.



QV Apex 302

Model	QV Apex 302			QV Apex 404			QV Apex 606			
Description	QV-X302P1L-D	QV-X302T1L-D	QV-X302P1C-D	QV-X404P1L-D	QV-X404T1L-D	QV-X404P1C-D	QV-X606P1L-D	QV-X606T1L-D	QV-X606P1C-D	
Measuring range	300x200x200 mm			400x400x250 mm			600x650x250 mm			
Observation unit*1	Programmable power turret 1X-2X-6X									
Tracking autofocus device	—	✓	—	—	✓	—	—	✓	—	
Illumination unit	Contour illumination	White LED			White LED			White LED		
	Vertical surface illumination	White LED	Color LED	—	White LED	Color LED	—	White LED	Color LED	
	PRL	White LED	Color LED	—	White LED	Color LED	—	White LED	Color LED	
Resolution of scale	0.1 μm									
Vision measuring accuracy*2	E _{ix} , E _{iy}	(1,5 + 3L/1000) μm								
	E _{iz}	(1,5 + 4L/1000) μm								
	E _{zxy}	(2,0 + 4L/1000) μm								
LAF Repeatability	—	σ≤0,8 μm	—	—	σ≤0,8 μm	—	—	σ≤0,8 μm	—	
Model with touch probe	QVT1-X302P1L-D	QVT1-X302T1L-D	QVT1-X302P1C-D	QVT1-X404P1L-D	QVT1-X404T1L-D	100	QVT1-X606P1L-D	QVT1-X606T1L-D	QVT1-X606P1C-D	
TP measuring accuracy*2	E _{ix} , E _{iy} , E _{iz} (1,8 + 3L/1000) μm									

*1 Programmable power turret 1X-2X-4X model and 1X-2X-4X-6X model are available for special order. *2 Determined by Mitutoyo's inspection method.

Hyper QV

High-accuracy CNC Vision Measuring System



- The Hyper QV is a highly accurate model that is equipped with a high-resolution/accuracy scale.
- We offer a model with tracking autofocus that can quickly focus on the object and thus improve throughput significantly.
- There is a general-purpose model with white LED light and an enhanced edge detection model with RGB color LEDs.
- This model is standard equipped with an automatic temperature compensation function that uses a temperature sensor on the main unit of the measuring machine and a temperature sensor for the workpiece.



Hyper QV 404

Model	Hyper QV 302			Hyper QV 404			Hyper QV 606			
Description	QV-H302P1L-D	QV-H302T1L-D	QV-H302P1C-D	QV-H404P1L-D	QV-H404T1L-D	QV-H404P1C-D	QV-H606P1L-D	QV-H606T1L-D	QV-H606P1C-D	
Measuring range	300x200x200 mm			400x400x250 mm			600x650x250 mm			
Observation unit*1	Programmable power turret 1X-2X-6X									
Tracking autofocus device	—	✓	—	—	✓	—	—	✓	—	
Illumination unit	Contour illumination	White LED			White LED			White LED		
	Vertical surface illumination	White LED	Color LED	—	White LED	Color LED	—	White LED	Color LED	
	PRL	White LED	Color LED	—	White LED	Color LED	—	White LED	Color LED	
Resolution of scale	0.02 μm									
Vision measuring accuracy*2	E _{ix} , E _{iy}	(0,8 + 2L/1000) μm								
	E _{iz}	(1,5 + 2L/1000) μm								
	E _{zxy}	(1,4 + 3L/1000) μm								
LAF Repeatability	—	σ≤0,8 μm	—	—	σ≤0,8 μm	—	—	σ≤0,8 μm	—	
Models with touch probe	QVT1-H302P1L-D	QVT1-H302T1L-D	QVT1-H302P1C-D	QVT1-H404P1L-D	QVT1-H404T1L-D	QVT1-H404P1C-D	QVT1-H606P1L-D	QVT1-H606T1L-D	QVT1-H606P1C-D	
TP measuring accuracy*2	E _{ix} , E _{iy} , E _{iz} (1,7 + 3L/1000) μm									

*1 Programmable power turret 1X-2X-4X model and 1X-2X-4X-6X model are available for special order. *2 Determined by Mitutoyo's inspection method.

QV HYBRID TYPE 1

Non-contact Laser Probe-Equipped CNC Vision Measuring System



- This complex system with a non-contact displacement sensor has a scanning function that enables measurement of minute height differences and 3D shapes.
- The double-pinhole technique has been adopted as the detection method of the displacement sensor, as it is less directional compared with the knife-edge and triangulation techniques.
- The small laser spot with a diameter of about 2 μm makes it possible to measure ultra-small shapes.

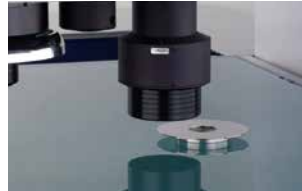

QV Hybrid Type1 Apex 404

Model	QVH1 302		QVH1 404		QVH1 606		
	Apex						
Description	QVH1-X302P1L-D		QVH1-X404P1L-D		QVH1-X606P1L-D		
Measuring range of vision probe	300x200x200 mm		400x400x250 mm		600x650x250 mm		
Measuring range of displacement sensor	180x200x200 mm		280x400x250 mm		480x650x250 mm		
Observation unit*1	Programmable power turret 1X-2X-6X						
Illumination unit	Contour illumination	White LED					
	Vertical surface illumination	White LED					
	PRL	White LED					
Resolution of scale	0,1 μm				0,02 μm		
Vision measuring accuracy*2	E _{1X} , E _{1Y}	(1,5 + 3L/1000) μm				(0,8 + 2L/1000) μm	
	E _{1Z}	(1,5 + 4L/1000) μm				(1,5 + 2L/1000) μm	
	E _{2ZY}	(2,0 + 4L/1000) μm				(1,4 + 3L/1000) μm	
Displacement sensor measuring accuracy	E _{1Z} (1,5 + 4L/1000) μm				(1,5 + 2L/1000) μm		

*1 Programmable power turret 1X-2X-4X model and 1X-2X-4X-6X model are available for special order. *2 Determined by Mitutoyo's inspection method.

QV HYBRID TYPE 4

Non-contact Laser Probe-equipped CNC Vision Measuring System



- This complex system with a non-contact displacement sensor has a scanning function that enables measurement of minute height differences and 3D shapes.
- The non-contact displacement sensor (CRS probe) uses the wavelength confocal method.
- The LED used as the light source of the displacement sensor has an auto-brightness control function that enables seamless measurement of materials with different reflectivity.

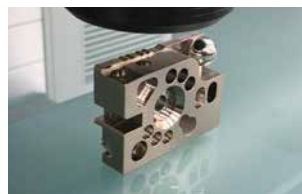

Hyper QV Hybrid Type4 606

Model	QVH4A 302		QVH4A 404		QVH4A 606		Hyper QVH4A			
	Apex	STREAM PLUS	Apex	STREAM PLUS	Apex	STREAM PLUS	302	404	606	
Description	QVH4A-X302P1L-D		QVH4A-X404P1L-D		QVH4A-X606P1L-D		QVH4A-H302P1L-D	QVH4A-H404P1L-D	QVH4A-H606P1L-D	
Measuring range of vision probe	300x200x200 mm		400x400x250 mm		600x650x250 mm		Same as Apex			
Measuring range of displacement sensor	176x200x200 mm		276x400x250 mm		476x650x250 mm		Same as Apex			
Observation unit*1	Programmable power turret 1X-2X-6X									
STREAM function	—	✓	—	✓	—	✓	—			
Illumination unit	Contour illumination	Blue LED	White LED	Blue LED	White LED	Blue LED	White LED			
	Vertical surface illumination	White LED	Color LED	White LED	Color LED	White LED	Color LED			
	PRL	White LED						White LED		
Resolution of scale	0,1 μm						0,02 μm			
Vision measuring accuracy*2	E _{1X} , E _{1Y}	(1,5 + 3L/1000) μm				(0,8 + 2L/1000) μm		(0,8 + 2L/1000) μm		
	E _{1Z}	(1,5 + 4L/1000) μm				(1,5 + 2L/1000) μm		(1,5 + 2L/1000) μm		
	E _{2ZY}	(2,0 + 4L/1000) μm				(1,4 + 3L/1000) μm		(1,4 + 3L/1000) μm		
Displacement sensor measuring accuracy	E _{1Z} (1,5 + 4L/1000) μm				(1,5 + 2L/1000) μm		(1,5 + 2L/1000) μm			

*1 Programmable power turret 1X-2X-4X model and 1X-2X-4X-6X model are available for special order. *2 Determined by Mitutoyo's inspection method.

QV STREAM PLUS

Non-stop CNC Vision Measuring System



- The main unit operation and the strobe light are synchronized to enable vision measurement without stopping the stage. As it is unnecessary to increase or decrease the stage speed, measurement becomes 5X faster than that of conventional models depending on the object type. (Compared with our conventional models.)

- The model with tracking autofocus performs continuous measurement by adapting to height differences, thus reducing the measurement time significantly.

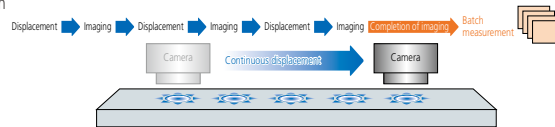

QV STREAM PLUS 606

Model	QV STREAM PLUS 302		QV STREAM PLUS 404		QV STREAM PLUS 606	
Description	QV-X302P15-D	QV-X302T15-D	QV-X404P15-D	QV-X404T15-D	QV-X606P15-D	QV-X606T15-D
Measuring range	300×200×200 mm		400×400×250 mm		600×650×250 mm	
Observation unit*1	Programmable power turret 1X-2X-6X					
Tracking autofocus device	—	✓	—	✓	—	✓
Illumination unit	Contour illumination		Blue LED			
	Vertical surface illumination		Color LED			
	PRL		Color LED			
Resolution of scale	0,1 μm					
Vision measuring accuracy*2	E _{ix} , E _{iy}		(1,5 + 3L/1000) μm			
	E _{iz}		(1,5 + 4L/1000) μm			
	E _{zxy}		(2,0 + 4L/1000) μm			
LAF Repeatability	—	σ≤0,8 μm	—	σ≤0,8 μm	—	σ≤0,8 μm

*1 Programmable power turret 1X-2X-4X model and 1X-2X-4X-6X model are available for special order. *2 Determined by Mitutoyo's inspection method.

Hyper QV WLI

Non-contact 3D Measuring System



- The Hyper QV WLI is a high-accuracy complex 3D measurement system consisting of QV and a white light interferometer.

- 3D surface texture analysis and 3D roughness analysis can be performed from 3D data captured by the WLI optical system. You can also perform dimensional measurement and cross-section measurement at a specific height using the 3D data.



Hyper QV WLI 606

Model	Hyper QV WLI 302		Hyper QV WLI 404		Hyper QV WLI 606	
Description	QVW-H302P1L-D		QVW-H404P1L-D		QVW-H606P1L-D	
Measuring range	Vision measurement	300×200×190 mm	400×400×240 mm		600×650×220 mm	
	WLI measurement	215×200×190 mm	315×400×240 mm		515×650×220 mm	
Observation unit*1	Programmable power turret 1X-2X-6X					
Illumination unit	Contour illumination		White LED			
	Vertical surface illumination		White LED			
	PRL		White LED			
	WLI optical head		Halogen			
Resolution of scale	0,01 μm					
Vision measuring accuracy*2	E _{ix} , E _{iy}		(0,8 + 2L/1000) μm			
	E _{iz}		(1,5 + 2L/1000) μm			
	E _{zxy}		(1,4 + 3L/1000) μm			
WLI Z-axis scanning range (max)	QV WLI A-5X, QV WLI A-10X: 6,3 mm, QV WLI A-25X: 3,2 mm, QV WLI A-50X: 1,0 mm					
WLI Z-axis repeatability*2	2σ≤0,08 μm					

*1 Programmable power turret 1X-2X-4X model and 1X-2X-4X-6X model are available for special order. *2 Determined by Mitutoyo's inspection method.

ULTRA QV

Ultra-High Accuracy CNC Vision Measuring System



- Ultra-high accuracy CNC vision measuring machine with measuring accuracy of E_{xy} (0,25 + L/1000) μm .
- Our proprietary high-resolution (0,01 μm) and high-accuracy low-expansion glass scales are used on the X, Y, and Z axes.
- The high-rigidity Y-axis table moving mechanism with a fixed bridge has been integrated with a reliable base made out of high stability granite.



ULTRA QV404

Model		ULTRA QV404	
Description		QV-U404P1N-D	QV-U404T1N-D
Measuring range		400x400x200 mm	
Observation unit*1		Programmable power turret 1X-2X-6X	
Tracking autofocus device		—	✓
Illumination unit	Contour illumination	Halogen	
	Vertical surface illumination	Halogen	
	PRL	Halogen	
Resolution of scale		0,01 μm	
Vision measuring accuracy*2	E_{ix} , E_{iy}	(0,25 + L/1000) μm	
	E_{iz} (50 mm stroke)	(1,0 + 2L/1000) μm	
	E_{iz} (Full stroke)	(1,5 + 2L/1000) μm	
	E_{zxy}	(0,5 + 2L/1000) μm	
LAF Repeatability		—	$\sigma \leq 0,8 \mu\text{m}$

*1 Programmable power turret 1X-2X-4X model and 1X-2X-4X-6X model are available for special order. *2 Determined by Mitutoyo's inspection method.

OPTIONS



QV Objectives

QV objectives

Objective	QV-SL0.5X*	QV-HR1X	QV-SL1X	QV-HR2.5X	QV-SL2.5X	QV-HR5X	QV-5X	QV-HR10X*	QV-10X*	QV-25X*
Order No.	02AKT199	02AKT250	02ALA150	02AKT300	02ALA170	02AWD010	02ALA420	02AKT650	02ALG010	02ALG020
Set of objectives that support PFF	—	—	—	02AKX895	—	—	02AKX900	02AKX905	—	02AKX910
Working distance	30,5 mm	40,6 mm	52,5 mm	40,6 mm	60,0 mm	20,0 mm	33,5 mm	20,0 mm	30,5 mm	13,0 mm
Field of view [mm] (H)×(V)	Turret 1X	12,54×9,4	6,27×4,7	2,49×1,86	1,24×0,93	0,62×0,47	0,25×0,18	0,25×0,18	0,12×0,09	0,04×0,03
	Turret 2X	6,27×4,7	3,13×2,35	1,24×0,93	0,62×0,47	0,25×0,18	0,12×0,09	0,12×0,09	0,04×0,03	—
	Turret 6X	2,09×1,56	1,04×0,78	0,41×0,31	0,20×0,15	0,10×0,07	—	—	—	—

* When the QV-SL0.5X, QV-HR10X, QV-10X, or QV-25X objective is used, some limitations, such as the illumination being insufficient depending on the workpiece, may occur.

Overall magnification with objective/turret combinations

Monitor magnification*1	15X	29X	58X	72X	87X	144X	173X	290X	430X	580X	720X	870X	1440X	1730X	4300X
Field of view [mm]	12,54×9,40	6,27×4,70	3,13×2,35	2,49×1,86	2,09×1,56	1,24×0,93	1,04×0,78	0,62×0,47	0,41×0,31	0,31×0,23	0,25×0,18	0,20×0,15	0,12×0,09	0,10×0,07	0,04×0,03
0,5X objective	●	●	●	●	●	●	●	●	●	●	●	●	●	●	●
1X objective	●	●	●	●	●	●	●	●	●	●	●	●	●	●	●
2,5X objective	●	●	●	●	●	●	●	●	●	●	●	●	●	●	●
5X objective	●	●	●	●	●	●	●	●	●	●	●	●	●	●	●
10X objective*2	●	●	●	●	●	●	●	●	●	●	●	●	●	●	●
25X objective*2	●	●	●	●	●	●	●	●	●	●	●	●	●	●	●

*1 The monitor magnification is a reference value when an image is displayed at 1X screen magnification on a 22-inch wide LCD monitor. QVPAK version 10 or later supports changing of video window size.

*2 When using a 10X or 25X objective lens in conjunction with a 2X or 6X power turret, illumination may be insufficient depending on the workpiece.

Calibration Chart and QV Compensation Chart

Calibration chart

A calibration chart is used to compensate for the pixel size of the CCD chip, and for the autofocus accuracy, and optical axis offset at each magnification of the variable magnification unit (PPT).

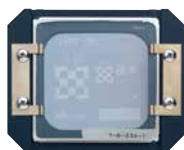

Note: There are limitations on the function, depending on the lens.
For details, contact your Mitutoyo sales office.

QV compensation chart

This glass chart is used to perform compensation for distortions within the screen caused by the optical system and autofocus compensation, which reduces autofocus variations that are caused by differences between the workpiece pattern and texture.



Note: There are limitations on the function, depending on the lens.
For details, contact your Mitutoyo sales office.

SOFTWARE

Application software that offers both functionality and operability

In addition to high-performance vision measuring functions, we offer a wide range of software for a variety of tasks such as shape analysis using a non-contact displacement sensor or even automatic creation of measurement programs. From simple to complex measurements, our lineup can resolve any measurement issues that our customers may encounter.

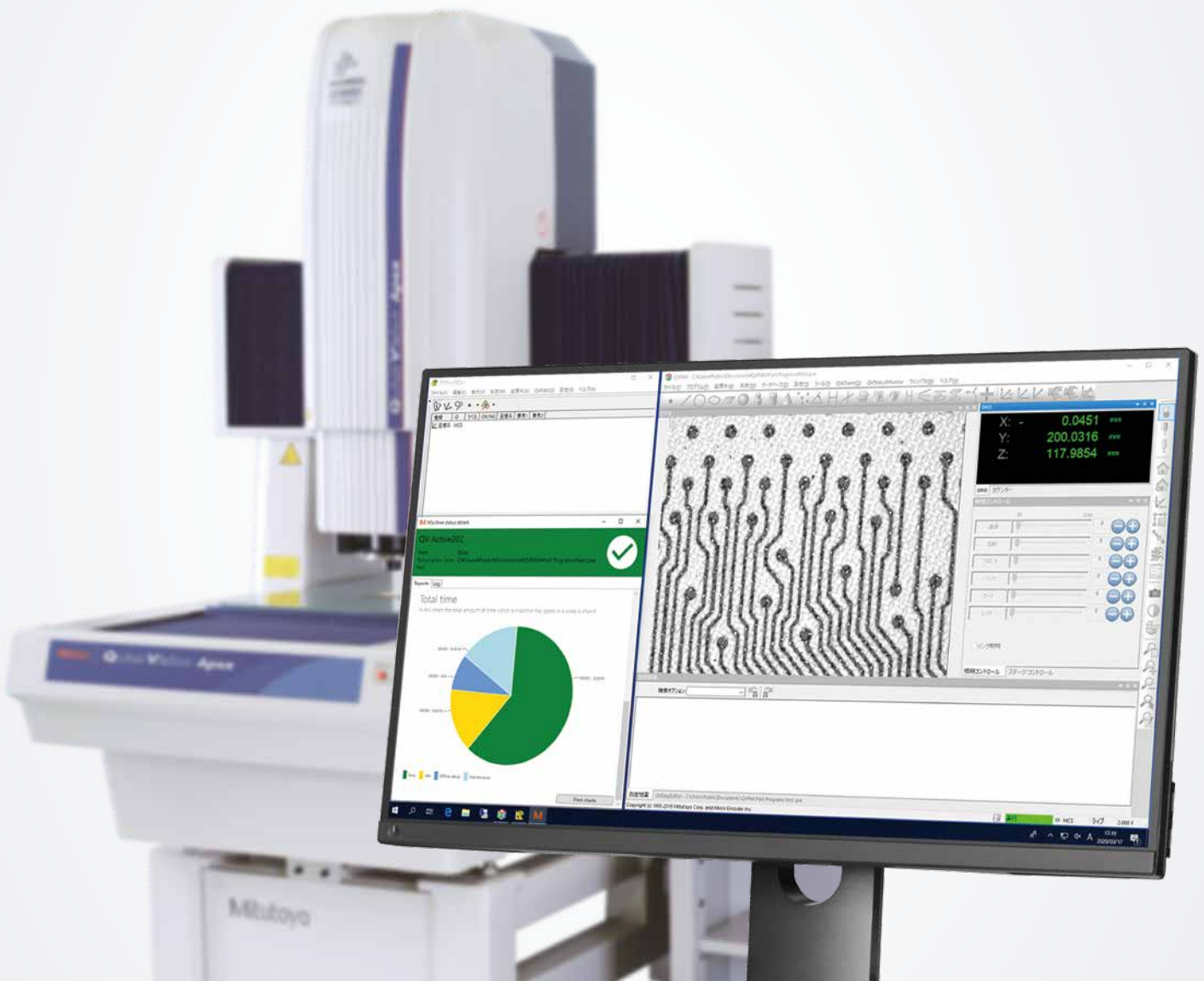

A rich choice of measuring functions

1 One-click Tool

Whatever your proficiency level, this function enables you to perform high-accuracy measurements by simply selecting the measurement item (circle, line, etc.) and clicking the edge to measure once. The abnormal point removing function automatically removes traces of burrs and contaminants.

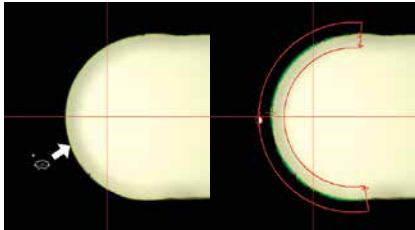

2 AI Illumination Tools

There are two useful tools that make use of AI, the dual area contrast tool, which can adjust the light intensity to the optimal value at procedure creation time, and the brightness tool, which automatically compensates the light intensity at program creation time. These tools stabilize the light intensity during repeat measurements, which increases edge detection repeatability and reduces the occurrence of edge detection errors caused by light intensity fluctuations.

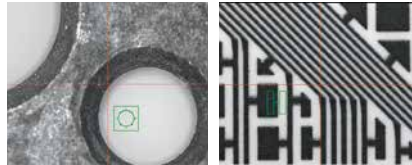

Brightness Tool

Dual Area Contrast Tool

3 Multi-point Autofocus

You can subdivide an autofocus tool or set up multiple autofocus tools at desired sizes, positions, and angles.

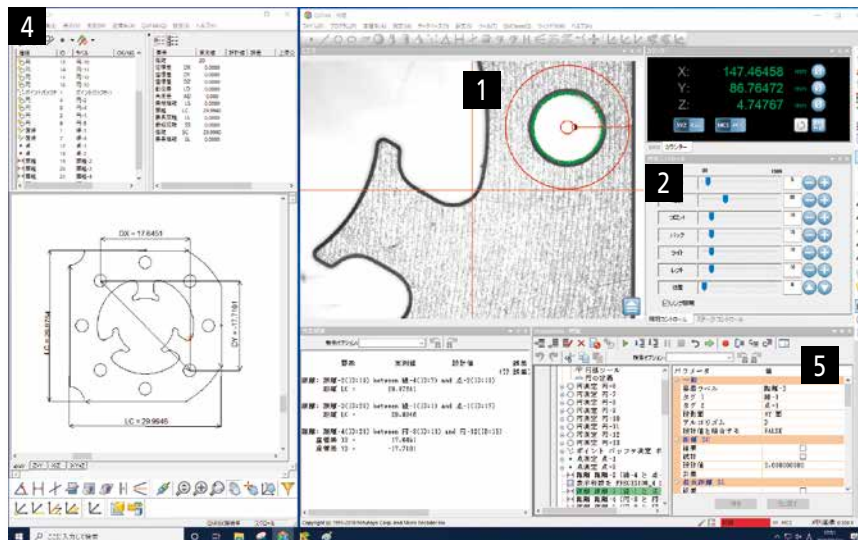
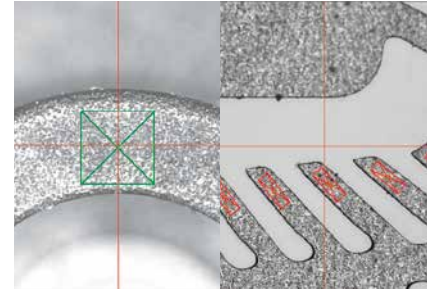

4 QV Graphics

Not only can this feature be used for reports of measurement results but also high-level calculations. Calculations between elements and PCD measurements can be performed by selecting diagrams with the mouse. In addition, effective use of the graphics function makes it possible to easily edit part programs and is also useful in checking the coordinate system of the current workpiece or for any forgotten measurements.

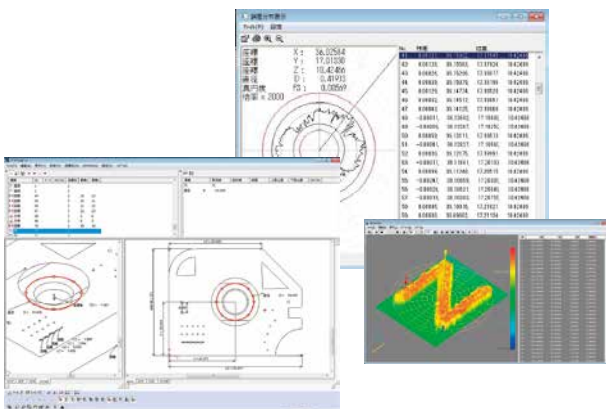

5 QV EasyEditor

QV EasyEditor allows you to record and edit the details of the operator's work with ease. The program list displays error icons for you to quickly find the parts to correct.

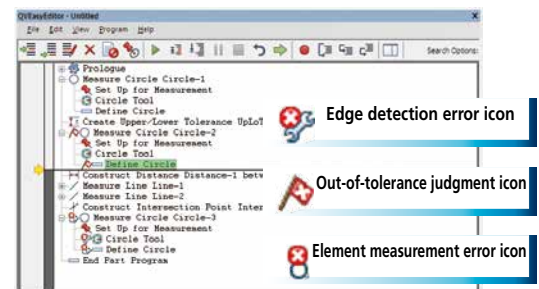

OPTIONAL SOFTWARE

FORMTRACEPAK-AP

Form Evaluation and Analysis Software

FORMTRACEPAK-AP performs tolerancing and form analysis from data obtained with the QV's auto trace tool, non-contact displacement sensor, HQV WLI, and PFF.

Contour Tolerancing Function

- Design data creation
CAD data conversion, master workpiece conversion, function specification, text file conversion, and aspherical surface design value creation
- Tolerancing
Normal vector direction tolerancing, axial direction tolerancing, and best-fit tolerancing

Microscopic Form Analysis

- Analyzed items: Point measurement, line measurement, circle measurement, distance measurement, intersection measurement, angle measurement, origin setting, and axial rotation
- Calculated items: Maximum, minimum, average, standard deviation, and area

Report Creation Function

- Measurement result, error graph, and error developed view

Other Functions

- Recording and executing analysis procedures
- External output function:
CSV, text, or DXF/IGES format output

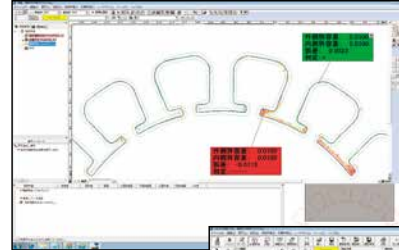

Tolerancing example

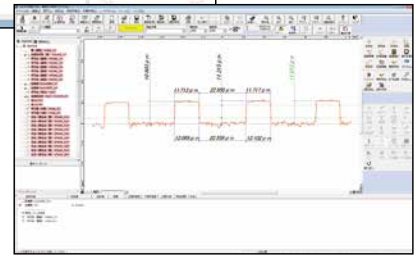

Example of using HQV WLI to perform line, space, and conductor thickness measurements on a printed circuit board

MCubeMap

3D Surface Property Analyzing Software

3D data captured by QV WLI can be analyzed according to parameters compliant with JIS B681-2: 2018 (ISO25178-6: 2010), including Sa, Sq, and other height parameters or 3D roughness parameters related to space, complexity, and functionality. 2D shapes can be analyzed and volumes measured from the 3D data captured by PFF or QV Hybrid.

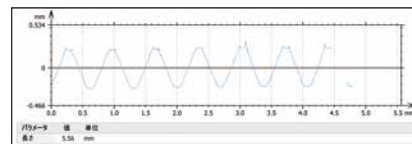
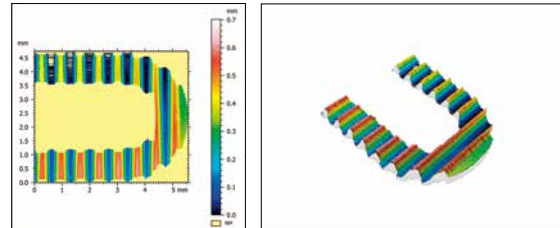

3D analysis of a shape captured with PFF

FORMTRACEPAK-PRO

Form Evaluation and Analysis Software

3D data captured by QV WLI can be analyzed for 3D surface roughness and surface texture. You can also analyze the displayed 3D shape information captured by the non-contact displacement sensor of the PFF or QV Hybrid.

Main Functions

- 3D display
Wire frame, shading, contour line, contour line filling
- Trend compensation and filter processing
Trend compensation using flat surfaces, spherical surfaces, cylindrical surfaces, and polyhedrons
1D and 2D digital filters for each profile
- Digitization of a rich variety of surface textures
Relative load curves and area distribution curves can be used to evaluate wear and oil accumulation areas.
Spectral analysis, cutoff area and volume analysis, angle of inclination calculations at peaks and valleys, and histogram calculations of numbers of valleys can be performed.
- Function for extracting features from measurement data
Extraction of a chosen cross section, slope enhancement, and simultaneous analysis of the peaks and valleys of the cutoff surface can be performed.

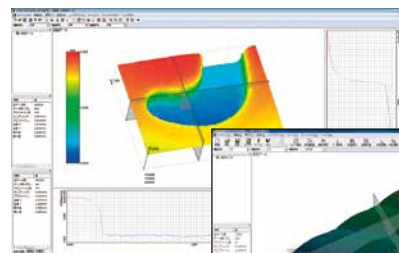

Example of using PFF to measure a molded component

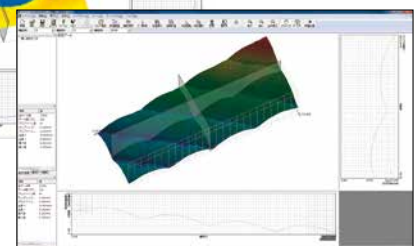

Example of using QVH4 to perform acrylic lens array measurements

EASYPAG - PRO

DXF **IGES** **GERBER data**

Offline Teaching Software

EASYPAG-PRO can use 2D CAD data to create QVPAK part programs in an offline manner. This reduces the number of man-hours required to create part programs, which results in a decrease in lead time.

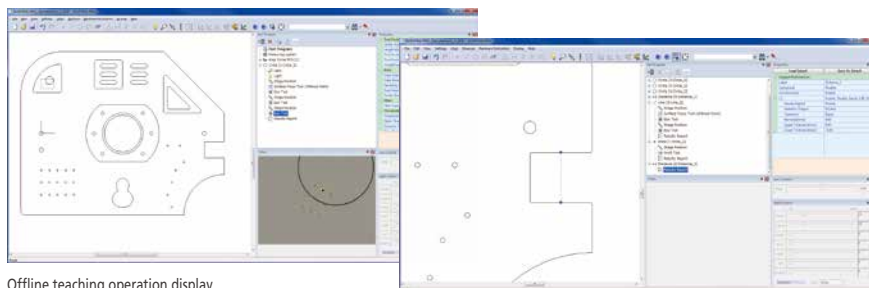

Offline teaching operation display

Line-to-arbitrary point distance measurement

QV3DCAD

This application creates a QV PAK part program from a 3D CAD model. The current version supports two modes: the online mode that allows you to teach while monitoring the actual workpiece by synchronizing the software with the QV system, and the offline mode that allows you to create a part program on a PC not connected to the main unit.

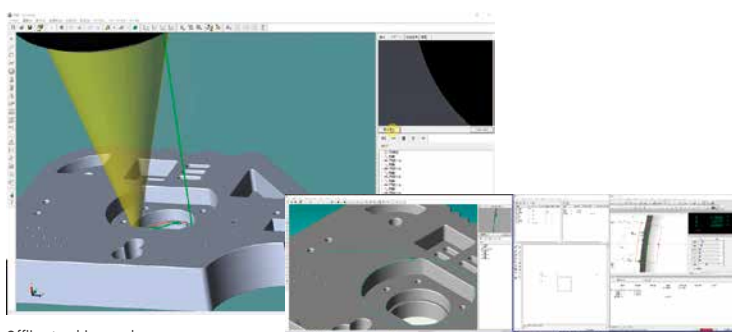

Offline teaching mode

Online teaching mode

MSURF-I

MSURF-I compares the 3D data captured by the QV Hybrid, QV WLI, or PFF with the design data of the 3D CAD model, etc.

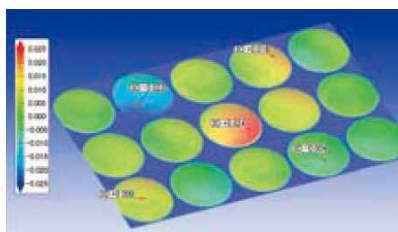

QV3DPAK

QV3DPAK is a software application that composes 3D forms from PFF (Point From Focus) or WLI (White Light Interferometer) data.

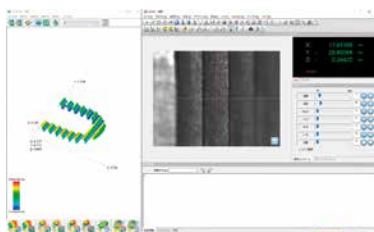

QVPartManager

QVPartManager is the part program execution management software for multiple workpieces arranged on the QV stage.

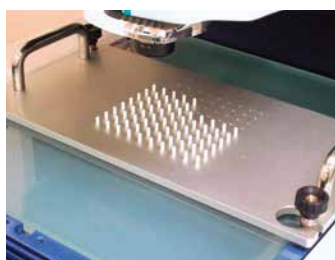

Workpieces arranged on a dedicated fixture



QVPartManager screen

SMART FACTORY

From status management to preventive maintenance.
Kickstart your smart factory through visualization.

Mitutoyo has developed new features that use a network to centrally manage manufacturing process information. MeasurLink predicts defects by collecting and analyzing measuring machine data in real-time. The status monitor (SMS: Smart Measuring System) that shows the operating status of the measuring machine also helps you improve productivity.



QVEio

IO application making the smart factory real

QVEio-PLC supported example

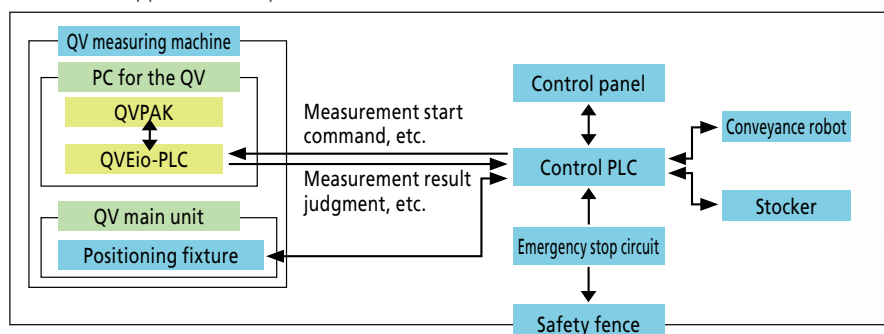



Status Monitor

Can remotely monitor measuring machines



MeasurLink

Reduces defective products by visualizing quality



INSPECTION

"DDPAK" - software for the Quick Vision Series that enables both flaw inspection and high-accuracy measurement

DDPAK is flaw inspection software for the Quick Vision. Use it during measurement to inspect for flaws, such as contaminants, burrs, and cracks while performing high-accuracy non-contact measurement at the same time.

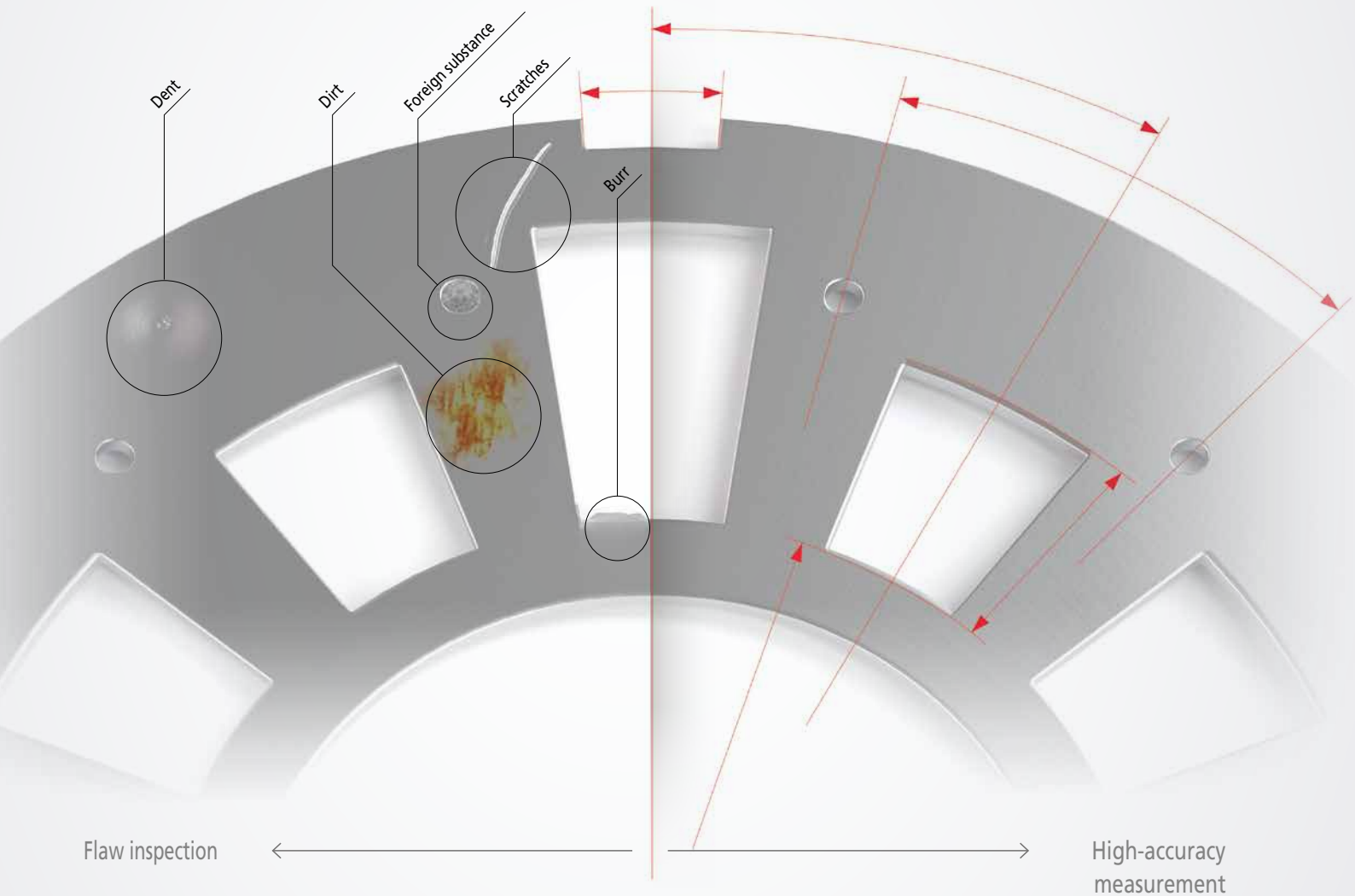

DDPAK

CNC Vision Measuring System Flaw Inspection Software

Dedicated for Quick Vision

■ Features

- Creates a seamless flaw inspection system that transfers the image data captured by the Quick Vision Series to DDPK, outputs the flaw coordinates, and automatically saves the image.
- Measures the dimensions of a flaw and analyzes its shape. Analyzing the coordinate, size, depth, height, and other statistics of a flaw can help analyze the cause, prevent recurrence, and improve the production process.
- You can add DDPK, the flaw inspection software, to your Quick Vision.

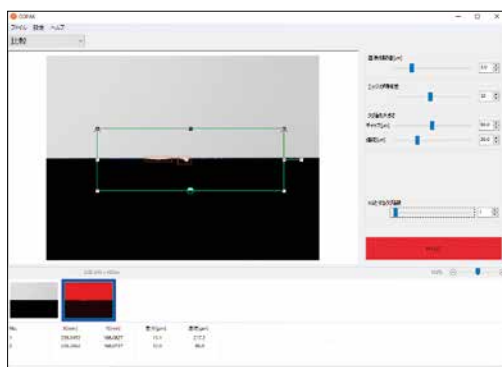

The image of the detected flaw turns red



Chipped blade

■ Flaw detection example

Chip on glass



Cracked glass



Print blurring on an electronic part

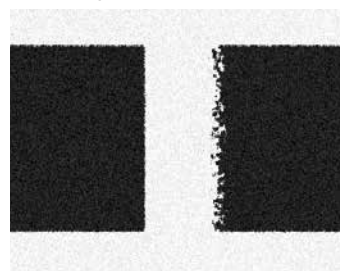

Foreign substance in a pore

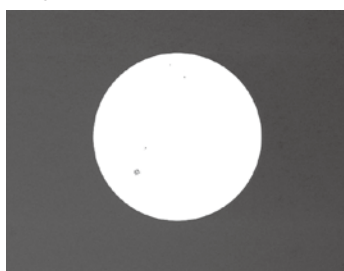

Scratched mirror-finished surface



Note: DDPK is available for special order. For details on supported workpieces and flaws, contact your local Mitutoyo sales office.



Mitutoyo supports you from start to finish.

Mitutoyo is not only a manufacturer of top-quality measuring products but one that also offers qualified support for the lifetime of the equipment backed up by comprehensive services, ensuring your staff can make the very best use of the investment.

Apart from the basics of calibration and repair, Mitutoyo offers product and metrology training, as well as IT support for the sophisticated software used in modern measuring technology. We can also design, build, test, and deliver bespoke measuring solutions and even, if deemed cost-effective, take your critical measurement challenges in-house on a sub-contract basis

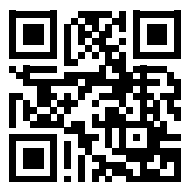

Find additional product literature
and our complete catalog here.

www.mitutoyo.eu

Note: MITUTOYO is either registered trademarks or trademarks of Mitutoyo Corp. in Japan and/or other countries/regions. Other product, company and brand names mentioned herein are for identification purposes only and may be the trademarks of their respective holders. Product illustrations are without obligation. Product descriptions, in particular any and all technical specifications, are only binding when explicitly agreed upon.

Mitutoyo

Mitutoyo Europe GmbH

Borsigstraße 8-10
41469 Neuss

Tel. +49 (0) 2137-102-0

Fax +49 (0) 2137-102-351

info@mitutoyo.eu

www.mitutoyo.eu