

# High-resolution Digimatic Measuring Unit LITEMATIC VL-50-B/50S-B/50AH

Catalog No. E13006



Low and constant measuring force of 0.01N, 0.15N, or 1N

**Mitutoyo**

Providing low and constant measuring force for high-accuracy inspection of delicate workpieces

# LITEMATIC VL-50-B/50S-B/50AH

## FEATURES

## VL-50-B/50S-B/50AH

- Patent registered (Japan), Patent pending (Japan)

### Ideal for measuring the thickness or height of a workpiece that can be easily affected by the measuring force

- With a measuring force of only 0.01N, the Litematic is ideal for measuring easily deformed workpieces or high-accuracy components.
- For workpieces for which 0.01N is insufficient, either the 0.15N or 1N model is recommended.
- The spindle is motor-driven and stops when the contact point touches the workpiece. From then on, the maximum, minimum, or difference value can be measured using a constant measuring force.

### High-accuracy measurement

- High resolution down to 0.01 $\mu$ m and a wide 50mm measurement range. The use of a low thermal-expansion material for the spindle and ceramic for the measuring table minimizes the effect of temperature variation during use. The unit is rust-free, simplifying maintenance and management.



Litematic VL-50-B

### Separate type VL-50S-B

Because the measuring unit and the display unit are separate, they can be integrated into the user's measurement system. An optional dedicated stand is also available.

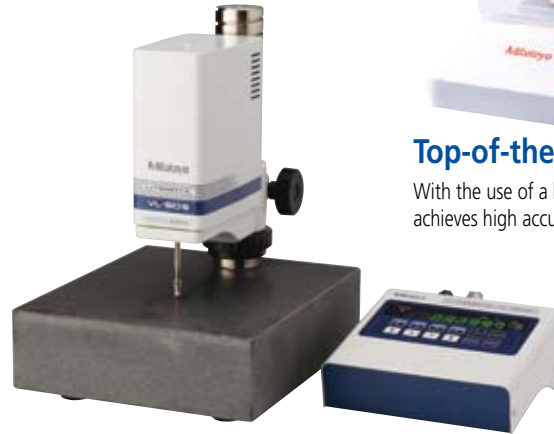

Litematic Head VL-50S-B



Super Litematic VL-50AH

### Top-of-the line model VL-50AH

With the use of a laser HoloScale, the Super Litematic VL-50AH achieves high accuracy of 0.15 $\mu$ m (0-35mm) or 0.25 $\mu$ m (35-50mm).

\*The stand (No.957460) is sold as an option.

### Constant measuring force principle

**An unbalanced, parallel-link structure enables the Litematic to offer a low and constant measuring force.**

The Litematic's measuring force is not provided by a spring but comes from a structure resembling a balance scale. We call this a "parallel linkage." A motorized slider carrying the linked spindle moves down its guideway while the linkage is supported on a stop, as shown in Fig. 1. When the spindle contacts the workpiece (Fig. 2) it moves the linkage up off the stop and the motor is halted. At this point the linkage is now supported by the workpiece, and thus a constant measuring force is applied.

Fig. 1. The spindle moves downwards towards the workpiece.

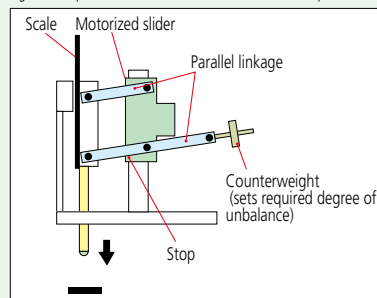
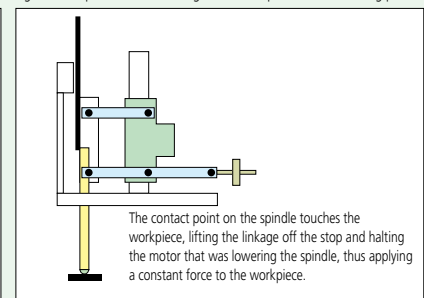

Fig. 2. The spindle lifts the linkage off the stop into the measuring position.



## Example Measurement Applications

### Rubber and plastic

If the workpiece is soft the risk of indentation may be reduced by replacing the standard contact point with one of larger radius, such as an optional carbide-ball type.

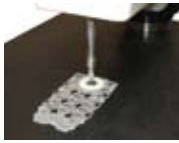

- ▶ Plastic
- ▶ Rubber
- ▶ Keypad



### Glass

For this type of workpiece the smallest measuring force available is recommended.



- ▶ Blue plate glass
- ▶ Lenses
- ▶ Contact lenses



### Film and sheet

If the workpiece flexes, making accurate measurement impossible, using a type with a larger measuring force or adding a weight to the spindle may be effective.



- ▶ Film
- ▶ Flexible substrates
- ▶ Various types of sheet



### Precision components

The Litematic can be used as a high-precision displacement gage.



- ▶ Bearing
- ▶ Shaft



### Thin sheet metal

Because the measuring force is small, deformation of the workpiece can be minimized.



- ▶ Chassis
- ▶ Shimming materials
- ▶ Blade springs
- ▶ Beverage can materials



### Media discs

For this type of workpiece the smallest measuring force available is recommended.



- ▶ Media tape
- ▶ Hard disks
- ▶ Various types of disks



### Medical and pharmaceutical products

If the workpiece is soft the risk of indentation may be reduced by replacing the standard contact point with one of larger radius, such as an optional carbide-ball type.



- ▶ Injection needles
- ▶ Pills
- ▶ Patches and ointments



### Semiconductors

If the workpiece flexes, making accurate measurement impossible, using a type with a larger measuring force or adding a weight to the spindle may be effective.

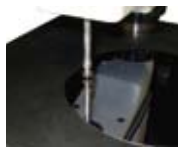

- ▶ Chips
- ▶ Wafers
- ▶ Lead frames



### Electronic components

For this type of workpiece the smallest measuring force available is recommended.



- ▶ Printed circuit boards
- ▶ Connectors
- ▶ Battery components



# LITEMATIC VL-50-B/50S-B/50AH

## FUNCTIONS

## VL-50-B/50S-B/50AH

### Control panel/Display Unit

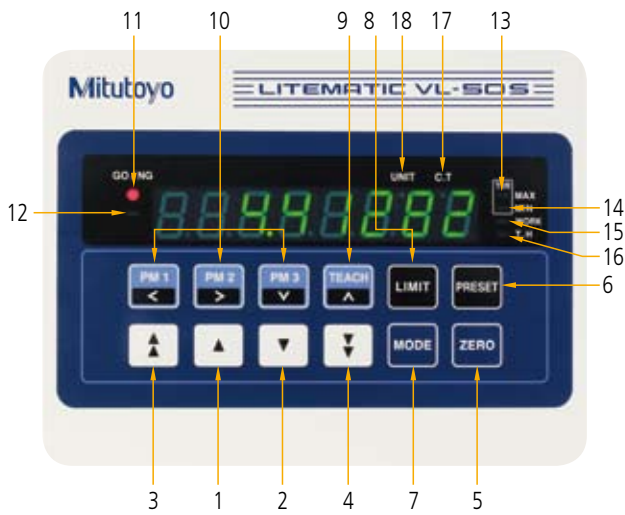

Key function	
Key	Function
1) Up	Moves the spindle up only while the key is pressed.
2) Down	Moves the spindle down only while the key is pressed. Used to touch the contact point on a workpiece to make a measurement.
3) Rapid Up	Moves the spindle up quickly only while the key is pressed.
4) Rapid Down	Moves the spindle down quickly only while the key is pressed.
5) ZERO	Sets the origin at any position of the spindle. Also, it zero-sets all display values for difference measurements. This key can be used to clear an error.
6) PRESET	Allows the currently displayed value to be set from the keyboard, irrespective of spindle position. Often used in conjunction with gauge blocks.
7) MODE	Selects and sets one of various measurement modes such as MAX/MIN measurement.
8) LIMIT	Enters tolerance limits for tolerance judgment.
9) TEACH	Sets up the position memory.
10) PM1 to Pm3	Moves the spindle to a previously stored position with a single keystroke.

Indicator (LED)		
Indicator	Function	
11) GO/NG	Displays the result of a GO/NG judgment.	
12) Sign	Lights to display a minus value.	
13) MAX	Lights in the maximum value mode.	Both light when the measurement is the difference type (MAX - MIN).
14) MIN	Lights in the minimum value mode.	
15) WORK	Lights while a workpiece is being measured.	
16) T.H.	Lights when a measurement value is held after measurement has been completed.	
17) C.T.	Lights when the user compensation is set to ON. (Lights while the position memory is active.)	
18) UNIT	Lights while the unit of display values is inch. (Lights in the external HOLD mode.)	

### Rear panel (switches and connectors)

#### VL-50-B

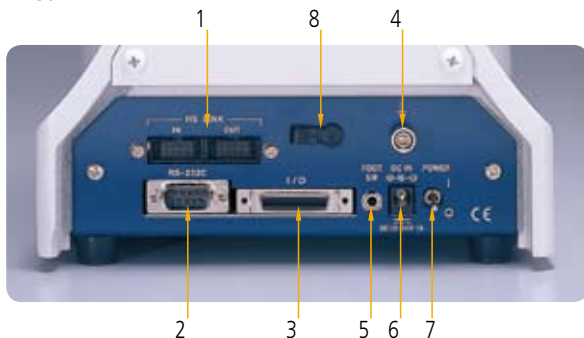

#### VL-50AH/50S-B

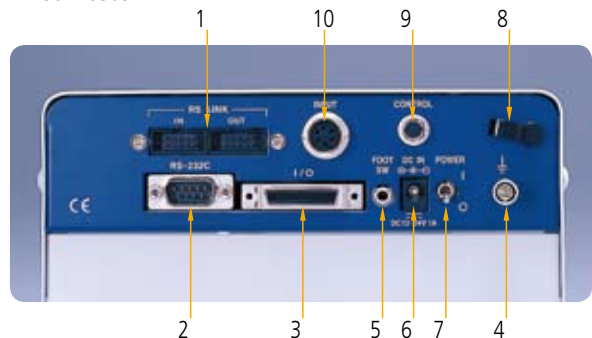

1) Measurement data output connector (OUT) RS-LINK connector (IN/OUT)	Outputs measurement data to a Digimatic mini-processor, etc. Connects multiple devices and can output measurement data from one RS-232 port.
2) RS-232C connector	For communication with a PC, etc.
3) External control connector	Used to connect this instrument to an external device for remote control.
4) GND terminal	—
5) Foot switch	Foot switch (optional) for controlling measurement operation is connected here.
6) DC IN	Input connector to receive power from the AC mains adapter.
7) Power switch	—
8) AC adapter cord clamp	Prevents AC adapter cord from pulling out.
9) CONTROL connector: for VL-50S-B only	Gage head connector.
10) INPUT connector: for VL-50S-B only	Gage head connector.

## SPECIFICATIONS

# VL-50-B/50S-B/50AH

Order No.	318-217	318-221	318-222	318-223	318-226	318-227	318-228	
Model	VL-50AH	VL-50-B	VL-50-15-B	VL-50-100-B	VL-50S-B	VL-50S-15-B	VL-50S-100-B	
Measuring Range* <sup>1</sup>	0-50mm (0 - 2")							
Resolution (selectable)	0.01/0.1/1.0μm (.0000005"/.000005"/.00005")							
Display unit	Character height 14mm (.6")/8 digits (excluding "minus" sign)							
Scale type	Laser Hologscale			4/4 Photoelectric reflection linear encoder				
Stroke	51.5mm (2") With standard contact point							
Accuracy at 20°C* <sup>1</sup>	0.15μm (0-35mm) 0.25μm (35-50mm)		(0.5+L/100)μm L = Measured length (mm)					
Accuracy guarantee temperature* <sup>2</sup>	20 ± 0.5°C			20 ± 1°C				
Repeatability* <sup>1</sup>	σ = 0.02 μm			σ = 0.05 μm				
Measuring force* <sup>1</sup>	0.01N		0.01N	0.15N	1N	0.01N	0.15N	1N
Spindle feed speed	Measuring	Approx. 1mm/s (.04"/s) / 2mm/s (.08"/s) / 3mm/s (.12"/s) (selectable by parameter)		Approx. 2mm/s (.08"/s) or 4mm/s (.16"/s) (selectable by parameter)				
	Quick feed	Approx. 5mm/s		Approx. 8mm/s (.3"/s)				
Standard contact point	ø5mm carbide contact point			ø3mm carbide ball				
Worktable	ø26 (Grooved Ceramic, Flatness = 0.07μm or better ø18)		ø100 (Ceramic, grooved, replaceable)					
Input	Data can be input with the foot switch							
Output	SPC output RS-232C output (switching by parameter)							
Power supply	85V to 264VAC (connected to AC adapter)							
Power consumption	Maximum 12W (12V, 1A)							
Main unit mass	21kg		19kg (35.2lbs)		6kg (11lbs)			
Standard accessories	• AC adapter: No.357651 • Power cord • Grounding wire: No.934626 • Allen wrench (for replacing the interchangeable contact point)							
Optional accessories	Foot switch: 937179T							
						Dedicated stand: 957460		
	Output connector (with cover): 02ADB440 (for external control)							
	RS-LINK/Digimatic connecting cable (1m): 936937 RS-LINK/Digimatic connecting cable (2m): 965014							
	Recommended interchangeable contact points: the following dial indicator interchangeable contact points are mountable.							
	Interchangeable contact point: Shell contact point		Part No.: 101118		Measuring force*: Approx 0.02N			
	Interchangeable contact point: Carbide ball ø7.5		Part No.: 120059		Measuring force*: Approx 0.03N			
	Interchangeable contact point: Carbide ball ø10.5		Part No.: 120060		Measuring force*: Approx 0.06N			
	Interchangeable contact point: Carbide needle ø 0.45		Part No.: 120066		Measuring force*: Approx 0.01N			
	Note: When another contact point that has a flat measuring face is mounted, the contact point requires parallelism adjustment with respect to the table surface. Mounting this contact point should be custom-ordered from Mitutoyo.							
VL weight parts		02AZE375		Measuring force*: Approx 0.01N to 0.96N				
Note: The above VL weight parts are dedicated weight parts for VL-50-B (VL-50A) and VL-50S-B (VL-50AS). Be careful when setting a measuring force of 1N or greater as this may cause equipment failure.								

\* Additional measuring force that is applied when non-standard contact points or VL weights are used.

\*1 Using the standard contact point.

\*2 Temperature variation must be gradual. The instrument must not be exposed directly to hot or cold drafts.

# LITEMATIC VL-50-B/50S-B/50AH

## DIMENSIONS

(Unit: mm)

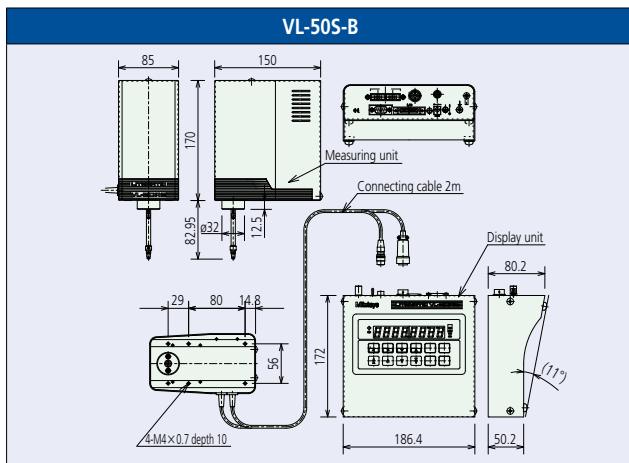
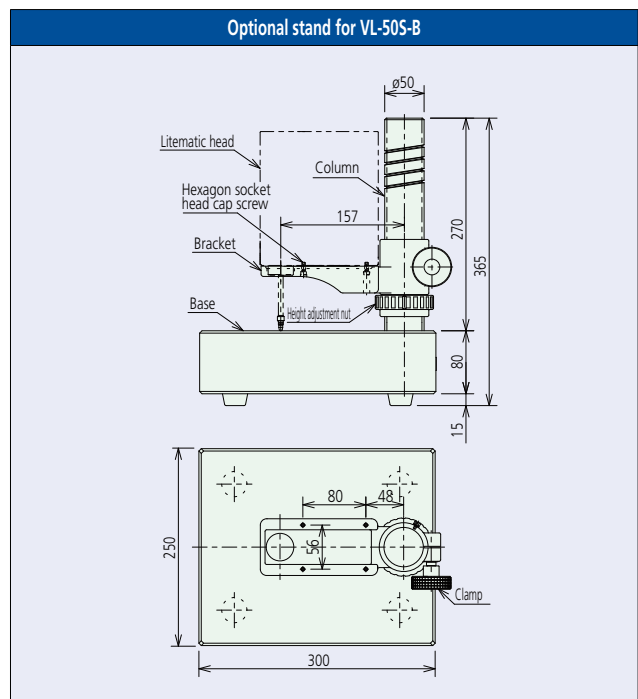
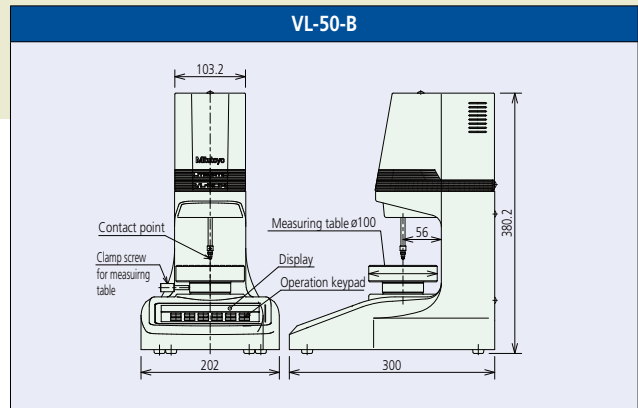
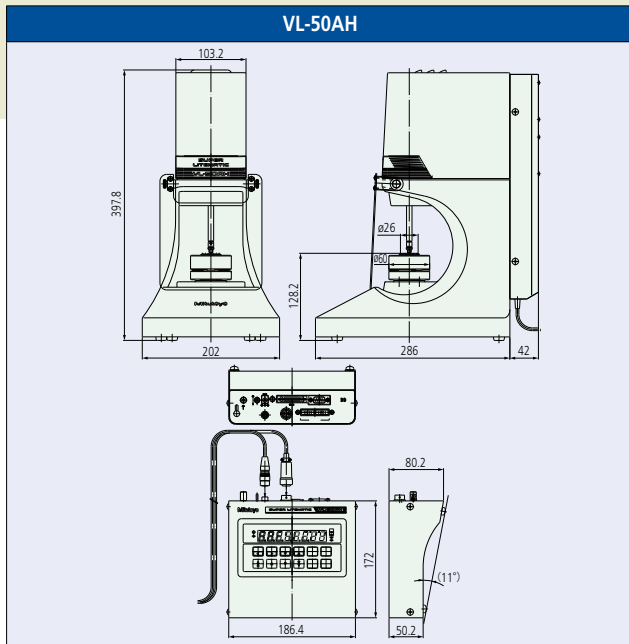

## Interchangeable contact points

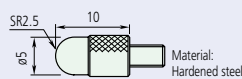

Order No.	Additional measuring force
101118	0.02N

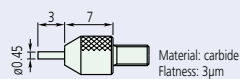

Order No.	Additional measuring force
120066	0.01N

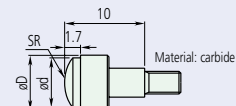

Order No.	Additional measuring force	D	d	SR
120059	0.03N	ø7.5	ø6.5	7
120060	0.06N	ø10.5	ø9.5	10

Note: When a contact point having a flat measuring surface, other than those described above, is installed, the measuring surface must be adjusted for parallelism with the table surface. This requires a special order.

## • Optional weights for the Litematic (No. 02AZE375)

One of the notable characteristics of the Litematic is its small measuring force (0.01N or 0.15N models). However, depending on the characteristics of the workpiece, it may not be possible to transmit a sufficient measuring force and the contact point may appear suspended. To solve such a problem, optional weights are available that attach to the spindle to achieve the appropriate measuring force without damaging the workpiece.

\* Cannot be used with VL-50AH, VL-50-100-B, or VL-50S-100-B

Spindle with an optional weight installed



External appearance of optional weights



Measuring forces generated by weight combinations for 0.01/0.15N models

Measuring force (N)		Extension rod	A	B	C
VL-50-B/50S-B	VL-50-15-B/50S-15-B				
0.01	0.15				
0.06	0.21	1			
0.16	0.31	1			1
0.26	0.41	1		1	
0.36	0.51	1		1	1
0.46	0.61	1	1		
0.56	0.71	1	1		1
0.66	0.81	1	1	1	
0.76	0.91	1	1	1	1
0.86	—	1	2		
0.96	—	1	2		1

# • Connector terminal Function

## 1) Applicable plugNo.02ADB440

No.02ADB440 (with cover) Optional accessory

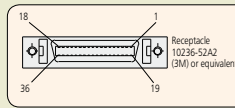

Applicable plug specification  
 10136-3000VE (3M: Plug)  
 10336-52AO-008 (3M: Cover)  
 DX40M-36P (Hirose: Plug)  
 DX30M-36-CV (Hirose: Cover)

## 2) Pin assignment

Pin No.	Signal name	Input/Output	Description (purpose)																					
1	COM	—	Common terminal to input and output circuits (internally connected to GND)																					
2	COM	—																						
3	L1	OUT	Tolerance judgment output terminal A related judgment terminal only outputs "L" At error occurrence L1, L5 = Outputs "L" L2, L3, L4 = Outputs "H"																					
4	L2	OUT																						
5	L3	OUT																						
6	L4	OUT																						
7	L5	OUT																						
10	NOM	OUT	Outputs "L" in the count mode.																					
21	ULIMIT	OUT	Outputs "L" at the top dead point of the spindle.																					
22	WORK	OUT	Outputs "L" upon detection of a workpiece.																					
25	SET1	IN	Specifies peak selection/motor speed in combination with SET.																					
26	SET2	IN																						
28	MODE	IN	Peak selection: In combination with SET																					
			<table border="1"> <thead> <tr> <th>Peak mode</th> <th>SET2</th> <th>SET1</th> </tr> </thead> <tbody> <tr> <td>Current value</td> <td>H</td> <td>H</td> </tr> <tr> <td>MAX</td> <td>H</td> <td>L</td> </tr> <tr> <td>MIN</td> <td>L</td> <td>H</td> </tr> <tr> <td>TIR</td> <td>L</td> <td>L</td> </tr> </tbody> </table>	Peak mode	SET2	SET1	Current value	H	H	MAX	H	L	MIN	L	H	TIR	L	L						
			Peak mode	SET2	SET1																			
			Current value	H	H																			
			MAX	H	L																			
			MIN	L	H																			
TIR	L	L																						
30	UP	IN	Motor control: Specifies a spindle ascent speed along with SET.																					
			When changing the spindle speed, stops the spindle once and allows 50ms or more before change.																					
			<table border="1"> <thead> <tr> <th>Speed</th> <th>VL-50B/50-S8</th> <th>VL-50AH</th> <th>SET2</th> <th>SET1</th> </tr> </thead> <tbody> <tr> <td>8mm/s</td> <td>5mm/s</td> <td>H</td> <td>H</td> </tr> <tr> <td>4mm/s</td> <td>3mm/s</td> <td>H</td> <td>L</td> </tr> <tr> <td>2mm/s</td> <td>2mm/s</td> <td>L</td> <td>H</td> </tr> <tr> <td>1mm/s</td> <td>1mm/s</td> <td>L</td> <td>L</td> </tr> </tbody> </table>	Speed	VL-50B/50-S8	VL-50AH	SET2	SET1	8mm/s	5mm/s	H	H	4mm/s	3mm/s	H	L	2mm/s	2mm/s	L	H	1mm/s	1mm/s	L	L
			Speed	VL-50B/50-S8	VL-50AH	SET2	SET1																	
			8mm/s	5mm/s	H	H																		
			4mm/s	3mm/s	H	L																		
2mm/s	2mm/s	L	H																					
1mm/s	1mm/s	L	L																					
31	DN	IN	Motor control: Specifies a spindle descent speed along with SET.																					
			When changing the spindle speed, stops the spindle once and allows 50ms or more before change.																					
			<table border="1"> <thead> <tr> <th>Speed</th> <th>VL-50B/50-S8</th> <th>VL-50AH</th> <th>SET2</th> <th>SET1</th> </tr> </thead> <tbody> <tr> <td>8mm/s</td> <td>5mm/s</td> <td>H</td> <td>H</td> </tr> <tr> <td>4mm/s</td> <td>3mm/s</td> <td>H</td> <td>L</td> </tr> <tr> <td>2mm/s</td> <td>2mm/s</td> <td>L</td> <td>H</td> </tr> <tr> <td>1mm/s</td> <td>1mm/s</td> <td>L</td> <td>L</td> </tr> </tbody> </table>	Speed	VL-50B/50-S8	VL-50AH	SET2	SET1	8mm/s	5mm/s	H	H	4mm/s	3mm/s	H	L	2mm/s	2mm/s	L	H	1mm/s	1mm/s	L	L
			Speed	VL-50B/50-S8	VL-50AH	SET2	SET1																	
			8mm/s	5mm/s	H	H																		
			4mm/s	3mm/s	H	L																		
2mm/s	2mm/s	L	H																					
1mm/s	1mm/s	L	L																					
32	FSW	IN	Motor control: Same function as that of foot switch.																					
34	HOLD	IN	The display value is held during input. At error occurrence the error is cleared at the leading edge of this signal.																					
35	P.SET	IN	Executes presetting. Peak clear: The peak value is cleared upon input of the signal during the HOLD signal input in the Peak mode.																					
	N.C.	—	Unconnected terminals (8, 9, 11-20, 23, 24, 27, 29, 33 and 36 pin terminals)																					

## (3) Input/output circuit

1. Output circuit: When the signal goes to "Low," the transistor turns on.  
(Open collector output)

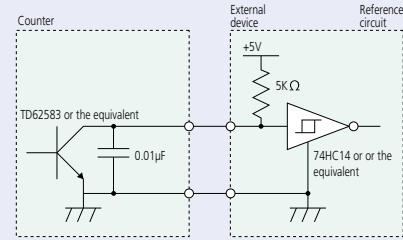

Maximum output voltage: 24V  
 Maximum output current: 20mA  
 Maximum saturation voltage: 0.7V

2. Input circuit: When the signal goes to "Low," the input is enabled.

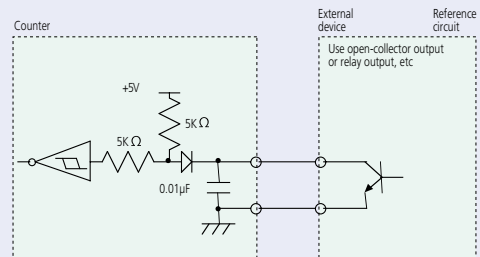

Maximum input current: 1mA  
 Input voltage (H): = 4-24V  
 Input voltage (L): = 1V max.

## (4) Timing Chart

### 1. Power On characteristics

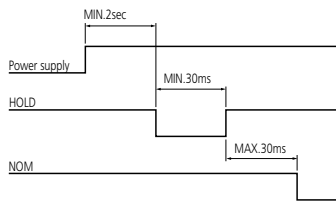

### 2. External presetting

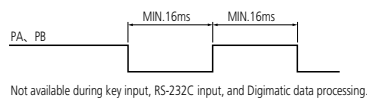

### 3. Tolerance judgment result output timing

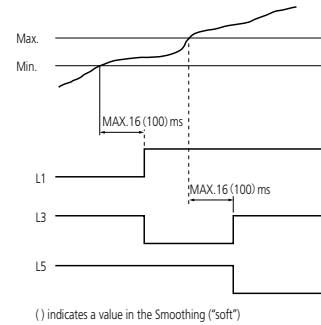

### 4. Mode/Up/DN timing

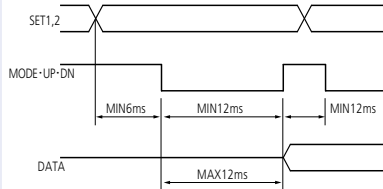

### 5. HOLD, Error clear

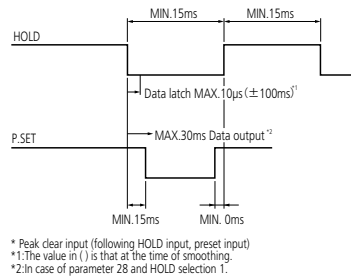

### 6. RS-232C command input and response output

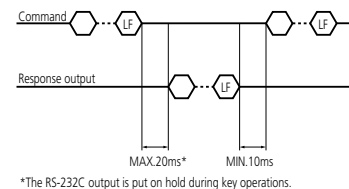

### RS-232C data output time

The maximum output time when the all-data-output command (GA00CRLF) is used can be calculated using the following formula:

$$\text{Maximum output time [ms]} = \text{counter connection count} \times 20 + \text{connected channel} \times 17 (8.5) + 6 (3)$$

\*At a transfer speed of 9,600 bps, figures inside ( ) indicate values [in ms] when the speed is 19,200 bps.

(Calculation example) 1 VL unit = MAX43 (31.5) ms (Note: The processing time by the personal computer is not included.)

# • RS-232C Communication Function

## (1) List of commands

Command format	Response output	Operation content
GA**CRLF	G***, +01234.567CRLF	A display value is output via RS-232C. “***” indicates gage channel numbers 01 to 99 (all channel number to 01 “#” indicates the type of data (N: current value, X: maximum value, M: minimum value, and W: TIR)CRLF stands for carriage return (CR) and line feed (LF).
CN**CRLF	CH**CRLF	The display is switched to the current value.
CX**CRLF	CH**CRLF	The display is switched to the maximum value.
CM**CRLF	CH**CRLF	The display is switched to the minimum value.
CW**CRLF	CH**CRLF	The display is switched to the TIR value.
CR**CRLF	CH**CRLF	The display is zero-set.
CL**CRLF	CH**CRLF	The peak value is cleared.
CP**,+01234567CRLF	CH**CRLF	The preset value is input. Input a preset value and a tolerance limit with a sign and a numeric value of 8 digits without appending a decimal point.
CD**,+01234567CRLF	CH**CRLF	Input tolerance limit S1. Perform tolerance setup in the order of CD and CG for 3-step tolerance judgment, and in the order of CD, CE, CF, and CG for 5-step tolerance judgment. An error message is output if there is a difference in tolerance limit order, or in the number of steps between the setting and data to be sent, or if incorrect data exists. If this is the case, repeat setup from the beginning of the CD command.
CE**,+01234567CRLF	CH**CRLF	Input tolerance limit S2.
CF**,+01234567CRLF	CH**CRLF	Input tolerance limit S3.
CG**,+01234567CRLF	CH**CRLF	Input tolerance limit S4.
CS**CRLF	CH**CRLF	An error is canceled.
VS**,+ \$ CRLF	CH**CRLF	Spindle control Sign +: Moves up the spindle, -: Moves down the spindle. \$: Speed specification 0: Stop 1: 2mm/s 2: 4mm 3: 8mm/s approx.
VT**,+ \$ CRLF	CH**,#CRLF	Staus of spindle condition In place of #, 0: Normal 1: Upper dead point limit 2: WORK ON Channel number 00 cannot be used.

## (2) Pin assignment

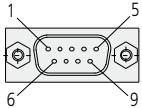

- Receptacle specification: D-sub 9-pin (male), inch thread spec.
- Applicable plug specification: D-sub 9-pin (female), inch thread spec.
- Commercial cable examples:  
For DOS/V: KRS-403XF1K (1.5m), Sanwa Supply Corp.  
For PC-98 series: KRS-423XF1K (1.5m), Sanwa Supply Corp.

Pin No.	Signal name	Input/Output	Definition
2	RXD	IN	Receive data
3	TXD	OUT	Transmit data
4	DTR	OUT	Data terminal ready
5	GND	—	Ground
6	DSR	IN	Data set ready
7	RTS	OUT	Request to send
8	CTS	IN	Clear to send
1, 9	N.C.	—	Unconnected

## (3) Communication protocol (EIA RS-232C compatible)

Home position	DTE (terminal) and cross cable are to be used.
Communication method	half-duplex, non-procedural
Baud rate	4800, 9600, 19200bps
Bit configuration	Start bit: 1 Data bits: (7 or 8) ASCII, uppercase Parity bit: None, even or odd Stop bits: 2
Communication condition setup	Set with parameters. See “3.3 List of Parameters”.

Export permission by the Japanese government may be required for exporting our products according to the Foreign Exchange and Foreign Trade Law. Please consult our sales office near you before you export our products or you offer technical information to a nonresident.

## Digimatic output function

\* The number of significant digits in the Digimatic output is 6.

### Data transmission to the PC

#### Input Tool IT-012U No. 264-012

Converts the Digimatic output from Litematic into keyboard signals and transfers to the PC.

Connecting cable (No.936937)



### Printer

#### Digimatic mini processor DP-1VR No. 264-504

Prints the Digimatic output from Litematic.

Connecting cable (No.936937)



- Coordinate Measuring Machines
- Vision Measuring Systems
- Form Measurement
- Optical Measuring
- Sensor Systems
- Test Equipment and Seismometers
- Digital Scale and DRO Systems
- Small Tool Instruments and Data Management

### Mitutoyo Corporation

20-1, Sakado 1-chome,  
Takatsu-ku, Kawasaki-shi,  
Kanagawa 213-8533, Japan  
T +81 (0) 44 813-8230  
F +81 (0) 44 813-8231  
<http://www.mitutoyo.co.jp>

Note: All information regarding our products, and in particular the illustrations, drawings, dimensional and performance data contained in this pamphlet, as well as other technical data are to be regarded as approximate average values. We therefore reserve the right to make changes to the corresponding designs, dimensions and weights. The stated standards, similar technical regulations, descriptions and illustrations of the products were valid at the time of printing. Only quotations submitted by ourselves may be regarded as definitive.

Our products are classified as regulated items under Japanese Foreign Exchange and Foreign Trade Law. Please consult us in advance if you wish to export our products to any other country. If the purchased product is exported, even though it is not a regulated item (Catch-All controls item), the customer service available for that product may be affected. If you have any questions, please consult your local Mitutoyo sales office.